

AQUA TROL®



Above-Ground Pool Automation
by

GOLDLINE
CONTROLS
A HAYWARD COMPANY

www.goldlinecontrols.com
888-921-POOL

IMPORTANT SAFETY INSTRUCTIONS

When using this electrical equipment, basic safety precautions should always be followed, including the following:

- **READ AND FOLLOW ALL INSTRUCTIONS**
- Disconnect all AC power during installation.
- Warning - To reduce the risk of injury, do not permit children to use this product unless they are closely supervised at all times.
- A green colored terminal marked "Earth Ground" is located inside the wiring compartment. To reduce the risk of electric shock, this terminal must be connected to the grounding means provided in the electric supply service panel with a continuous copper wire equivalent in size to the circuit conductors supplying the equipment.
- One bonding lug for US models (two for Canadian models) is provided on the external surface. To reduce the risk of electric shock, connect the local common bonding grid in the area of the swimming pool, spa, or hot tub to these terminals with an insulated or bare copper conductor not smaller than 8 AWG US / 6 AWG Canada.
- All field installed metal components such as rails, ladders, drains, or other similar hardware within 3 meters of the pool, spa or hot tub shall be bonded to the equipment grounding bus with copper conductors not smaller than 8 AWG US / 6 AWG Canada.
- **SAVE THESE INSTRUCTIONS**

Table of Contents

OPERATION

The Aqua Trol®	1
Water Chemistry.....	1
Controls.....	6
Maintenance.....	8

INSTALLATION

Mounting.....	9
Plumbing.....	10
Wiring.....	11

TROUBLESHOOTING

Troubleshooting.....	13
----------------------	----

WARRANTY

Warranty.....	15
---------------	----

OPERATION

The Aqua Trol® is an automatic chlorine generation system with a built-in filter pump timer designed specifically for above ground pools. The operation requires a low concentration of salt (sodium chloride) in the pool water at levels low enough that it normally will not be tasted. The Aqua Trol automatically sanitizes your pool by converting the salt into free chlorine which kills bacteria and algae in the pool through a process called electrolysis. Because chlorine will revert back to sodium chloride after killing the bacteria, these reactions will continuously recycle virtually eliminating the need to add sanitizing chemicals to your pool. The only time you may need to add more salt to the pool is when water is replenished due to backwashing, draining, or splashing (not evaporation).

The Aqua Trol incorporates a built in timer to control the pool filter. This timer insures that the proper daily filtration and sanitization occurs. The Aqua Trol is designed to handle the purification needs of the average residential above ground swimming pool of up to 18,000 gallons (67,500 liters). The actual amount of chlorination required to properly sanitize a pool varies depending upon bather load, rainfall, temperature, and the pool's cleanliness.

The Aqua Trol is available with several different options to allow for easy installation on a wide variety of above ground pools. The cell may be connected with 1½" - 1¼" flexible hose or to 2" rigid PVC pipe when the **-HP** option is ordered, or the cell may be mounted directly to the pool return jet when the **-RJ** version is ordered. Similarly, the electrical connections may be made via 120V/15A "straight blade" linecord and receptacle (standard Aqua Trol version, no option designation) or may be made via a 120V/20A "twist lock" linecord and receptacle when the **-TL** version is ordered.

AQ-Trol-HP	"Straight blade" 120V/15A linecord/receptacle; 2" (51mm) rigid PVC piping or 1½ - 1¼" (38-32mm) flexible hose
AQ-Trol-HP-TL	"Twist lock" 120/20A linecord/receptacle; 2" (51mm) rigid PVC piping or 1½ - 1¼" (38-32mm)flexible hose
AQ-Trol-RJ	"Straight blade" 120V/15A linecord/receptacle; adapters for return jet mounting
AQ-Trol-RJ-TL	"Twist lock" 120V/20A linecord/receptacle; adapters for return jet mounting

Before installing this product as part of a saline water purification system in an above-ground pool with an immediately adjacent natural stone patio/decking, a qualified stone installation specialist should be consulted regarding the appropriate type, installation, sealant (if any) and maintenance of stone used around a saline pool with electronic chlorine generator in your particular location and circumstances.

Water Chemistry

As with any pool, it is important that you maintain chemical makeup of the pool water. The table on page 2 summarizes the levels that are recommended by the

National Spa and Pool Institute (NSPI). The only special requirement for the Aqua Trol is the salt level and stabilizer. It is important to maintain these levels in order to prevent corrosion or scaling and to ensure maximum enjoyment of the pool. Test your water periodically. Your local pool store can provide you with the chemicals and procedures to adjust the water chemistry. Be sure to tell the pool store that you are using an Aqua Trol chlorine generator.

CHEMICAL	IDEAL LEVELS
Salt	2700 to 3400 ppm
Free Chlorine	1.0 to 3.0 ppm
pH	7.2 to 7.6
Cyanuric Acid (Stabilizer)	60 to 80 ppm (80 ppm best)
Total Alkalinity	80 to 120 ppm
Calcium Hardness	200 to 400 ppm
Metals	0 ppm
Saturation Index	-.2 to .2 (0 best)

Saturation index

The saturation index (Si) relates to the calcium and alkalinity in the water and is an indicator of the pool water "balance". Your water is properly balanced if the Si is 0 ±.2. If the Si is below -0.2, the water is corrosive and plaster pool walls will be dissolved into the water. If the Si is above +0.2, scaling and staining will occur. Use the equation and chart below to determine the saturation index.

$$Si = pH + Ti + Ci + Ai - 12.1$$

°C	°F	Ti	Calcium Hardness	Ci	Total Alkalinity	Ai
12	53	.3	75	1.5	75	1.9
			100	1.6	100	2.0
16	60	.4	125	1.7	125	2.1
			150	1.8	150	2.2
19	66	.5	200	1.9	200	2.3
			250	2.0	250	2.4
24	76	.6	300	2.1	300	2.5
			400	2.2	400	2.6
29	84	.7	600	2.4	600	2.8
			800	2.5	800	2.9
34	94	.8				
39	103	.9				

How to use: Measure pool pH, temperature, calcium hardness, and total alkalinity. Use the chart above to determine Ti, Ci, and Ai from your measurements. Insert values of pH, Ti, Ci and Ai into the above equation. If Si equals .2 or more, scaling and staining may occur. If Si equals -.2 or less corrosion or irritation may occur.

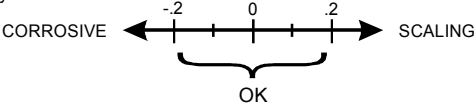

Salt Level

Use the chart on page 4 to determine how much salt in pounds (or Kgs) needs to be added to reach the recommended levels. Use the equations below (measurements are in feet/gallons and meters/liters) if pool size is unknown.

	Gallons (pool size in feet)	Liters (pool size in meters)
Rectangular	Length x Width x Average Depth x 7.5	Length x Width x Average Depth x 1000
Round	Diameter x Diameter x Average Depth x 5.9	Diameter x Diameter x Average Depth x 785
Oval	Length x Width x Average Depth x 6.7	Length x Width x Average Depth x 893

The ideal salt level is between 2700-3400 ppm (parts per million) with 3200 ppm being optimal. If the level is low, determine the number of gallons in the pool and add salt according to the chart on page 4. A low salt level will reduce the efficiency of the Aqua Trol[®] and result in low chlorine production. A high salt level can cause the Aqua Trol to shutdown and may begin to give a salty taste to your pool (generally, the salt will begin to be tasted at a level of about 3500-4000 ppm). The salt in your pool is constantly recycled and the loss of salt throughout the swimming season should be small. This loss is due primarily to the addition of water because of splashing, backwashing or draining (because of rain). Salt is not lost due to evaporation.

Type of Salt to Use

It is important to use only sodium chloride (NaCl) that is 99% pure. This is common food quality or water softener salt available in 40-80 lb. bags at your local Goldline dealer. It is also acceptable to use water conditioning salt pellets, however, it will take longer for them to dissolve. Do not use rock salt, salt with more than 1% yellow prussiate of soda, salt with more than 1% of anti-caking additives, or iodized salt.

How to Add or Remove Salt

Turn the filter pump on and add the salt directly into the pool. Brush the salt to speed up the dissolving process--to not allow the salt to sit in a pile on the bottom of the pool. Run the filter pump for 24 hours with the suction coming from the main drain (use the pool vacuum if there is not main drain) to allow the salt to evenly disperse throughout the pool. The salt display may take 24 hours to respond to the change in salt concentration.

The only way to lower the salt concentration is to partially drain the pool and refill with fresh water.

**POUNDS and (Kg) OF SALT NEEDED FOR 3200 PPM
Gallons and (Liters) of Pool/Spa water**

Current salt level ppm	Gallons and (Liters) of Pool/Spa water						
	6,000 (22,500)	8,000 (30,000)	10,000 (37,500)	12,000 (45,000)	14,000 (52,500)	16,000 (60,000)	18,000 (67,500)
0	160 (73)	213 (97)	267 (121)	320 (145)	373 (170)	427 (194)	480 (218)
200	150 (69)	200 (91)	250 (114)	300 (136)	350 (159)	400 (182)	450 (205)
400	140 (64)	187 (85)	233 (106)	280 (127)	327 (148)	373 (170)	420 (191)
600	130 (59)	173 (79)	217 (98)	260 (118)	303 (138)	347 (158)	390 (177)
800	120 (55)	160 (73)	200 (91)	240 (109)	280 (127)	320 (145)	360 (164)
1000	110 (51)	147 (67)	183 (83)	220 (100)	257 (117)	293 (133)	330 (150)
1200	100 (46)	133 (61)	167 (76)	200 (91)	233 (106)	267 (121)	300 (136)
1400	90 (41)	120 (55)	150 (68)	180 (82)	210 (95)	240 (109)	270 (123)
1600	80 (36)	107 (48)	133 (61)	160 (73)	187 (85)	213 (97)	240 (109)
1800	70 (32)	93 (42)	117 (53)	140 (64)	163 (74)	187 (85)	210 (95)
2000	60 (27)	80 (36)	100 (45)	120 (55)	140 (64)	160 (73)	180 (82)
2200	50 (23)	67 (30)	83 (38)	100 (45)	117 (53)	133 (61)	150 (68)
2400	40 (18)	53 (24)	67 (30)	80 (36)	93 (42)	107 (48)	120 (55)
2600	30 (14)	40 (18)	50 (23)	60 (27)	70 (32)	80 (36)	90 (41)
2800	20 (9)	27 (12)	33 (15)	40 (18)	47 (21)	53 (24)	60 (27)
3000	10 (4)	13 (6)	17 (8)	20 (9)	23 (11)	27 (12)	30 (14)
3200	Ideal	Ideal	Ideal	Ideal	Ideal	Ideal	Ideal
3400	OK	OK	OK	OK	OK	OK	OK
3600+	Dilute	Dilute	Dilute	Dilute	Dilute	Dilute	Dilute

Stabilizer (Cyanuric Acid)

Always check stabilizer (cyanuric acid), when checking salt. These levels will most likely decline together. Use the chart below to determine how much stabilizer must be added to raise the level to 80 ppm.

POUNDS and (Kg) OF STABILIZER (CYANURIC ACID) NEEDED FOR 80 PPM

Gallons and (Liters) of Pool/Spa water

Current Stabilizer Level (ppm)	6,000 (22500)	8,000 (30000)	10,000 (37500)	12,000 (45000)	14,000 (52500)	16,000 (60000)	18,000 (67500)
0 ppm	4.0 (1.8)	5.3 (2.4)	6.7 (3.0)	8.0 (3.6)	9.4 (4.3)	10.7 (4.9)	12.0 (5.4)
10 ppm	3.5 (1.6)	4.7 (2.1)	5.8 (2.6)	7.0 (3.2)	8.2 (3.7)	9.4 (4.3)	10.5 (4.8)
20 ppm	3.0 (1.4)	4.0 (1.8)	5.0 (2.3)	6.0 (2.7)	7.0 (3.2)	8.0 (3.6)	9.0 (2.2)
30 ppm	2.5 (1.1)	3.3 (1.5)	4.2 (1.9)	5.0 (2.3)	5.9 (2.7)	6.7 (3.0)	7.5 (3.4)
40 ppm	2.0 (.9)	2.7 (1.2)	3.3 (1.5)	4.0 (1.8)	4.7 (2.1)	5.4 (2.4)	6.0 (2.7)
50 ppm	1.5 (.7)	2.0 (.9)	2.5 (1.1)	3.0 (1.4)	3.5 (1.6)	4.0 (1.8)	4.5 (2.0)
60 ppm	1.0 (.5)	1.3 (.6)	1.7 (.8)	2.0 (.91)	2.4 (1.1)	2.7 (1.2)	3.0 (1.4)
70 ppm	0.5 (.2)	0.7 (.3)	0.8 (.4)	1.0 (.45)	1.2 (.54)	1.4 (.64)	1.5 (.68)
80 ppm	0.0	0.0	0.0	0.0	0.0	0.0	0.0

Controls

Timer

The pool filter pump should run long enough to circulate the entire volume of pool water each day. This will vary depending on pump size, pool plumbing and pool size. Consult a local pool store to help determine the appropriate run time for your pool.

Set the Aqua Trol's timer by rotating the clock hands in a clockwise direction. The arrow (positioned approximately 2 o'clock on dial) points to the current time. The internal "hands" show time at a glance. On the outside of the timer, there are a series of small slide trippers. Each tripper controls a 15 minute interval. Set the trippers for the desired run time.

OFF - Push trippers IN (toward center)

ON - Pull trippers OUT (away from center)

Manual Control

There is a switch on the timer (located at approximately the 4 o'clock position) that allows the pump to be manually turned on or off.

"1" (up) - pump ON

" " (center) - timer controls pump

"0" (down) - pump OFF

Main Switch

AUTO: For normal operation, the Main Switch should be left in the AUTO position. In this position the Aqua Trol® will produce chlorine according to the "Desired Level %" adjustment setting for the entire filtering/pumping cycle.

SUPER CHLORINATE: When you have an abnormally high bather load, a large amount of rain, a cloudy water condition, or any other condition which needs a large amount of purification to be introduced, put the Main Switch in the SUPER CHLORINATE position. This electronically "super chlorinates" (shocks) the water for 24 hours (filter pump must be on during this time) or until the power has been turned off, whichever comes first. At the end of the super chlorinate time, be sure to put the switch back into the AUTO position.

OFF: The OFF position prevents the Aqua Trol from energizing the electrolytic cell. In this position there is no chlorine generation. **NOTE:** To service any of the pool equipment or the Aqua Trol, turn the power off at the circuit breaker.

"Desired Level %" adjustment knob

This setting is used to control the amount of chlorine the Aqua Trol generates. Raise this setting to increase chlorine level and lower it to decrease chlorine level.

Indicator LED's

POWER When illuminated, the Aqua Trol has input power.

GENERATING This LED is on steady during normal operation. When flashing, the pool water is too hot or cold to operate.

SUPER CHLORINATE Illuminates during Super Chlorination. See description above.

NO FLOW When illuminated, the flow switch has detected no flow and the Aqua Trol® has stopped generating chlorine. A flashing LED indicates a 15/60 second time delay period.

TEST SALT LEVEL When flashing, the salt level is low (below 2700ppm) and Aqua Trol is generating at low efficiency. When illuminated steady, the salt level is too low and Aqua Trol has shut down. Before adding large quantities of salt, it is advisable to have your salt level professionally checked.

HIGH SALT When illuminated, the salt level is too high and Aqua Trol has shut down.

INSPECT CELL A flashing indicator signifies that either the cell efficiency is reduced or that it is time for regularly scheduled cell inspection. In either case, inspect the cell and clean if necessary. Pressing the "diagnostic" button next to the display for 3 seconds will stop the flashing LED. When illuminated steady, cell efficiency is greatly reduced and the Aqua Trol has stopped producing chlorine. Inspect, clean or replace if necessary.

Salt Display

The Salt Display shows the current salt concentration of the pool water. Readings are in ppm (parts per million). Refer to the Water Chemistry section for recommended salt levels as well as how to add/remove salt.

The factory default display is in English (ppm). If Metric units (grams per liter) are preferred, push the "diagnostic" button next to the display once. The display will now show the pool water temperature in degrees Fahrenheit. With the temperature displayed, move the main switch from AUTO to SUPER CHLORINATE to AUTO. The temperature display will instantly change to degrees Celsius and the salt display will switch to grams/liter. Repeat this process to switch back to English units (ppm and Fahrenheit).

Operation

By understanding how the Aqua Trol operates, you'll be sure to use it more effectively for maximum convenience and performance. Assuming that the water chemical levels are in the recommended range, there are three factors that you can control which directly contribute to the amount of chlorine the Aqua Trol will generate:

1. filter time each day (hours)
2. the amount of salt in the pool
3. the "Desired Level %" setting

To find the optimum "Desired Level %" setting, start at a fairly high setting and work downward. It will take a few days of adjustments to find the ideal setting for your pool/spa. Once determined, it should only take minor adjustments, if at all, to compensate for differing salt levels due to splashing, backwashing, rain, etc. Because the production of chlorine is affected by water temperature, it is important to check chlorine levels during periods of unusually high or low pool water temperatures. The Aqua Trol control will not produce chlorine at temperatures below 50° F. If your pool will be below this temperature for any length of time, you must chlorinate manually.

Maintaining the Aqua Trol® System

To maintain maximum performance, it is recommended that you open and visually inspect the cell every 3 months or after cleaning your filter. The Aqua Trol will remind you to do this by flashing the "Inspect Cell" LED after approximately 500 hours of operation. After you inspect the cell (and clean, if necessary) press the small "diagnostic" button next to the display for 3 seconds to stop the flashing "Inspect Cell" LED and start the timer for the next 500 hour inspection period.

The Aqua Trol electrolytic cell has a self cleaning feature incorporated into the electronic control's logic. In most cases this self cleaning action will keep the cell working at optimum efficiency. In areas where water is hard (high mineral content) and in pools where the water chemistry has been allowed to get "out of balance", the cell may require periodic cleaning. The "Inspect Cell" LED will indicate if cell efficiency is decreased and servicing is necessary. If the "Inspect Cell" LED remains on after a thorough cleaning, the cell may be worn and require replacement.

Servicing and Cleaning the Aqua Trol cell

Turn off power to the Aqua Trol before removing the electrolytic cell. Once removed, look inside the cell and inspect for scale formation (light colored crusty or flaky deposits) on the plates and for any debris which has passed through the filter and caught on the plates. If no deposits are visible, reinstall. If deposits are seen, use a high pressure garden hose and try to flush the scale off. If this is not successful, use a plastic or wood tool (do not use metal as this will scratch the coating off the plates) and scrape deposits off of the plates. Note that a buildup on the cell indicates that there is an unusually high calcium level in the pool (old pool water is usually the cause). If this is not corrected, you can expect to have to periodically clean the cell. The simplest way to avoid this is to bring the pool chemistry to the recommended levels as specified.

Mild Acid Washing: Use only in severe cases where flushing and scraping will not remove the majority of deposits. To acid wash, turn off power to Aqua Trol. Remove cell from piping. In a clean plastic container, mix a 4:1 solution of water to muriatic acid (one gallon of water to one quart of muriatic acid). ALWAYS POUR ACID INTO WATER - NEVER POUR WATER INTO ACID. Be sure to wear rubber gloves and appropriate eye protection. The level of the solution in the container should just reach the top of the cell so that the wire harness compartment is NOT submerged. It may be helpful to coil the wiring before immersing the cell. The cell should soak for a few minutes and then rinse with a high pressure garden hose. If any deposits are still visible, repeat soaking and rinsing. Replace cell and inspect again periodically.

Winterizing

The Aqua Trol electrolytic cell and flow detection switch will be damaged by freezing water just as your pool plumbing would. In areas of the country which experience severe or extended periods of freezing temperatures, be sure to drain all water from the pump, filter, and supply and return lines before any freezing conditions occur. The electronic control is capable of withstanding any winter weather and should not be removed.

Spring Start-up

DO NOT turn the Aqua Trol on, until the pool water chemistry has been brought to the proper levels. This information can be found on page 2.

INSTALLATION

Installation must be performed in accordance with Local and NEC codes.

Preparing Pool Water

Refer to page 2 for recommended chemical levels. The pool's chemistry must be balanced **BEFORE** activating the Aqua Trol. **NOTE:** If the pool does not have new water, add 1 quart (1 liter) of metal remover and 1 quart (1 liter) of non-copper based algaecide to the pool, per manufacturers instructions. This ensures a quick, troublefree transfer to the Aqua Trol system.

Mounting the Aqua Trol Control

The Aqua Trol is contained in a raintight enclosure that is suitable for outdoor mounting. The control must be mounted a minimum of 5 ft. (2 meters) horizontal distance (or more if local codes require) from the pool.

The control is designed to mount vertically on a flat surface. Because the enclosure also acts as a heat sink (disperses heat from inside the box), it is important not to block the four sides of the control. Do not mount the Aqua Trol in a panel or tight enclosed area.

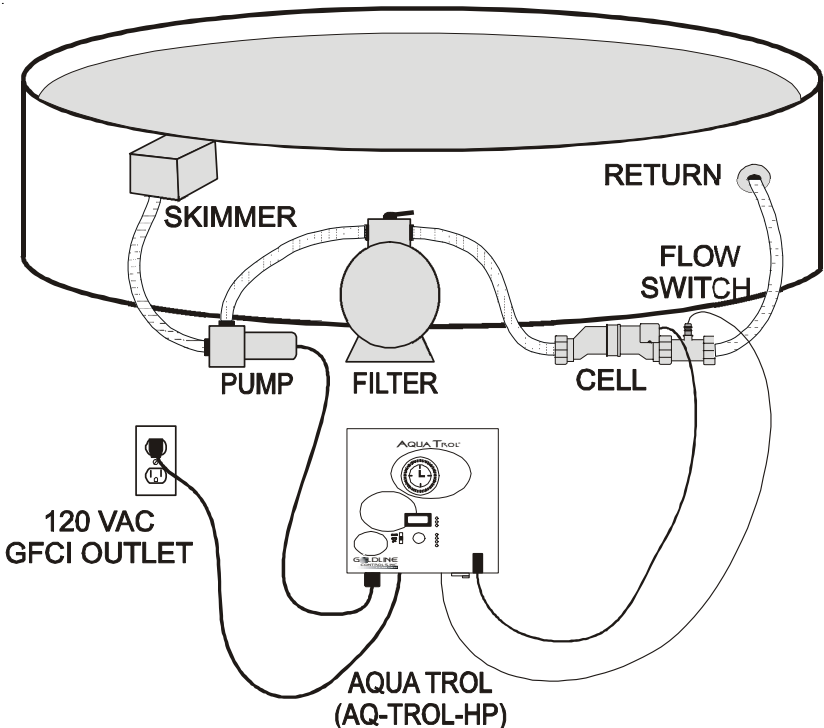

Plumbing

The cell and flow switch (not used on -RJ systems) are plumbed in the return line to the pool. Install after (downstream) all the pool equipment (filter, heater, solar, etc.). The kit included in the Aqua Trol provides the necessary plumbing components for either 2" (51mm) rigid PVC piping installation or 1½ - 1¼" (38-32mm) flexible hose installation. An overview of the Aqua Trol system with the hose/pipe installation (-HP) is shown on the previous page, see below for detail on the return jet mounting.

Hose/Pipe installations (-HP option): Install the cell and flow switch as shown in the diagrams below. Always make sure that the flow switch is downstream from the cell. When using the hose adaptors, remove the o-ring from the pipe union tailpiece and install them in the hose tailpieces. Tighten all union nuts **BY HAND** for a watertight seal.

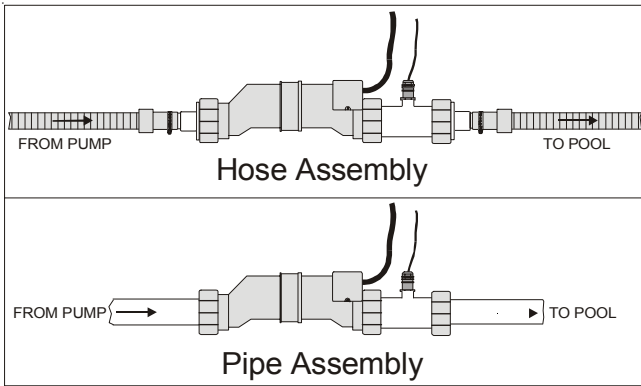

Return Jet installation (-RJ option): Unscrew the the hose adaptor from the pool return jet fitting and, in its place, screw in the right-angle cell mounting adaptor. Note that this installation does NOT require a flow switch--however it is very important that the cell be mounted vertically directly below the return jet in order to allow the gases produced in the cell to naturally dissipate in the pool. Attach the cell to the union and then use the fittings supplied to attach the lower end of the cell to either the hose or rigid PVC pipe coming from the pools filtration system. Tighten all union nuts **BY HAND** for a watertight seal.

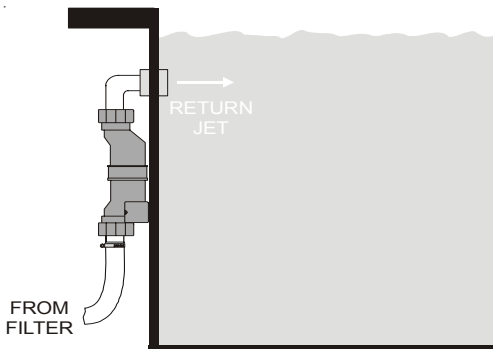

Wiring

Power must be shut off at the circuit breaker before performing any wiring. Be sure to follow Local and NEC/CEC electrical codes. The Aqua Trol has been designed to easily wire into typical above ground pool systems. To provide safe operation, the Aqua Trol must be properly grounded and bonded.

Input Power

Models with the standard 120 VAC line cord should be plugged into a GFCI receptacle. Twist lock models should be plugged into a twist lock receptacle wired to a GFCI circuit breaker. For Canadian installations: Connect to a circuit protected by a Class-A ground fault interruptor. See diagram below.

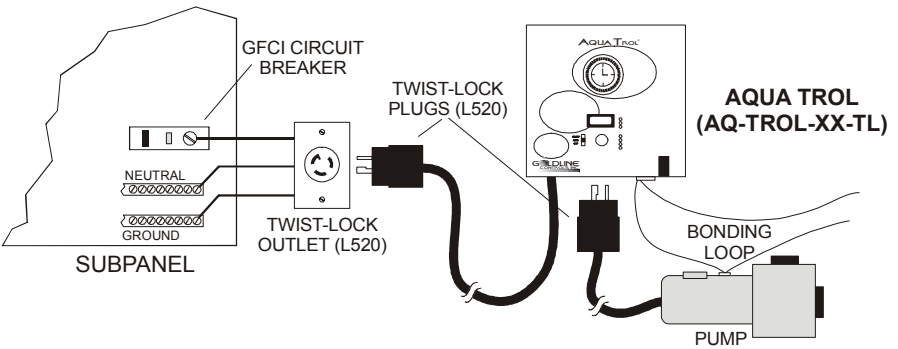
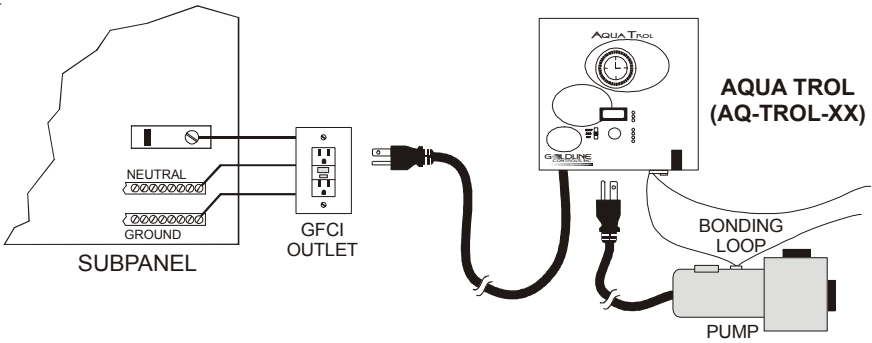

Bonding

A lug used for bonding is attached to the bottom of the Aqua Trol enclosure. Connect to the pool bonding system using minimum 8AWG copper wire if required by code.

Pump Output

The Aqua Trol's filter pump output is rated at 120 VAC, 15 A max. Check the electrical rating marked on the pump motor. Connecting a pump with a higher amperage rating may result in permanent damage to the Aqua Trol. The 120 VAC standard or twist lock pump receptacle is located outside, on the bottom of the enclosure.

Electrolytic Cell and Flow Switch

The cell and flow switch plug into connectors on the Aqua Trol electronics unit. Note that return jet units (-RJ option) will NOT have a flow switch. See diagram below.

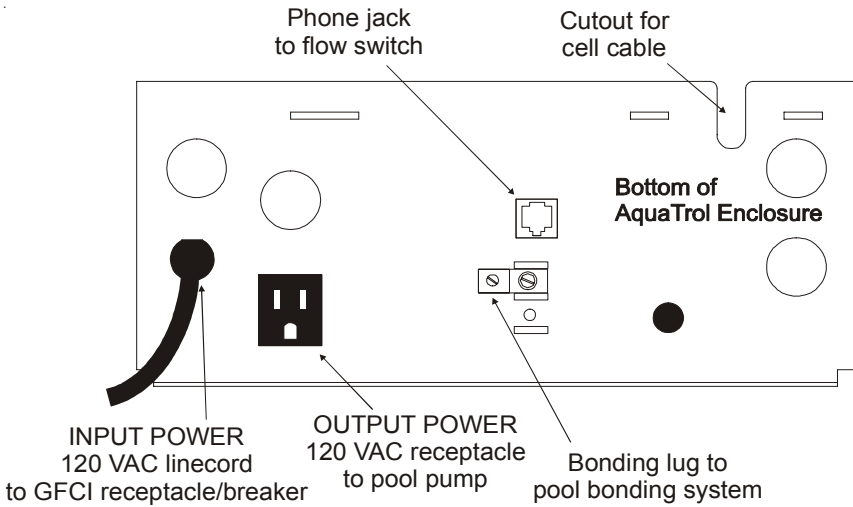

Troubleshooting

Visit www.goldlinecontrols.com for helpful information on operation, maintenance and troubleshooting your Aqua Trol® Electronic Chlorine Generator. You may also call for technical assistance at 888-921-POOL. Technicians at the factory are available from 8:00 AM to 8:00 PM Eastern Standard Time, Monday through Friday. Be sure to have the following information when you call:

1. Model and Serial # of control and cell
2. Date of installation
3. Installing Company or Dealer
4. Salt level

Diagnostic Displays

Sequential pushes of the small "diagnostic" button next to the LCD display will cause the Aqua Trol to display the following information:

1. Pool temperature (xx degrees Fahrenheit or Celsius)
2. Cell voltage (typically 22.0 to 26.0 volts when chlorine is being generated, otherwise 30-35V)
3. Cell current (typically 2.50 to 4.00 amps when chlorine is being generated, otherwise 0 amps)
4. Desired Output % ("0P" -- "100P" depending on knob position)
5. Instant salinity (-xxxx ppm or -x.xx grams/Liter)
6. Product name sent to the display ("AL-6" signifies "Aqua Trol" (STD), ("AL-7" signifies "Aqua Trol Return-Jet")
7. Software revision level (r1.xx)

On the 8th push of the button the display will revert back to the default salt display. Also, if the button is not pushed for 30 seconds, the display will revert back to the standard salt display.

Common Problems and Solutions

1. "Power" LED not on

Check to make sure 120VAC input power is connected to the Aqua Trol control. Verify input voltage with a voltmeter. If there is input power, the fuse may have blown. The Aqua Trol is protected by a 20 amp mini ATO fuse located on the circuit board above the cell connector.

2. Filter pump not running

Check that the time clock manual switch is in the "auto" (center) position or in the "on" (top) position. If in "auto", then check that the time is correct (check am/pm by using the 24 hour indicator located near the 2 o'clock position) and that the trippers are in the "out" position.

3. "Generating" LED not on

The Aqua Trol only generates chlorine when the filter pump is running, the main switch is in the "AUTO" or "SUPER CHLORINATE" position, and none of the red fault LEDs are illuminated.

4. "Generating" LED flashing

The temperature of the pool water is too high or low to operate. You can override this by switching the main switch to SUPER CHLORINATE. The Aqua Trol will run at maximum output for the remainder of the current pump cycle or 24 hours, whichever comes first.

5. "No Flow" LED illuminated

The Aqua Trol® has sensed a no flow condition and has stopped generating chlorine. Check that the flow switch is plugged into the connector on the bottom of the control unit and that the wire is not cut or damaged. Make sure you have at least 12" of straight pipe before the flow switch. If there is adequate flow and the LED is still on, check that the arrows on the flow switch (on top of hex) are pointing in the direction of flow.

6. "Test Salt Level" LED illuminated or flashing

Take a sample of your pool water to your local Authorized Aqua Rite Dealer and have the salt level tested. No salt test is completely accurate and the test results may vary from the salt level on the Aqua Trol display. If salt level is low, add salt according to chart on page 4.

7. "High Salt" LED illuminated

Check salt level in pool/spa. If salt level is too high, lower salt level by draining some of the pool water out of the pool and replace with fresh water. Continue until the salt concentration is at recommended levels.

8. "Inspect Cell" LED flashing

Inspect and clean cell according to directions on page 8. When done, press the "diagnostic" button for 3 seconds to stop the "Inspect Cell" LED flashing.

9. "Inspect Cell" LED illuminated

Remove and inspect the cell for scale. If the cell is scaled, follow the directions on page 8 for cell cleaning. If the pool has the proper amount of salt and the "Inspect Cell" LED is still illuminated, the cell may be worn and need replacement.

10. Possible causes of little or no free chlorine residual

- Aqua Trol switch in OFF position.
- Desired Level % adjustment setting is too low.
- Low stabilizer (Cyanuric Acid).
- Filter pump switched off or filter pump time too short (8 hours for average size pools, more for large pools)
- Salt level too low (below 2500 ppm, Low Salt LED on).
- Salt level too high (High Salt LED on).
- Very warm pools increase chlorine demand--increase Desired Level % or filter run time.
- Cold water (below 50F) causes Aqua Trol to stop generating (Generating LED flashing).
- Excessive scaling on cell.
- High level of Nitrogen in pool water.
- "Yellow Out" or similar treatment recently used. Some yellow algae treatments will use chlorine at a very high rate and deplete the residual free chlorine. Manually shock the pool if indicated in the directions on the algae treatment. It still may be a matter of days before the pool returns to "normal" and chlorine tests will show the desired 1-3ppm free chlorine reading.

11. "-Pcb-" displayed and all 4 red/yellow LEDs are illuminated.

A possible Printed Circuit Board fault has been detected. Call for service.

LIMITED WARRANTY Goldline warrants its Aqua Rite, Aqua Rite Pro, Aqua Trol, Aqua Logic and Pro Logic products (products with Goldline part numbers starting with AQ-RITE-, AQ-RT-PRO, AQ-TROL-, AQ-LOGIC-, AQL-P-, AQL-PS-, AQL-CL-, PL-P-, PL-PS-, and HPC-2) to be free from defects in material or workmanship, under normal use and service:

For **three years** from the date of the initial system installation on private, residential swimming pools within the USA or Canada and **one year** from the date of initial system installation on commercial installations, installations outside of the USA or Canada and for any replacement parts or accessory products, provided they are installed in accordance with the Goldline installation instructions and specifications provided with the product. If written proof of the date of the initial system installation is not provided to Goldline, the manufacturing datecode on the Aqua Rite, Aqua Rite Pro, Aqua Trol, Aqua Logic and Pro Logic electronics unit will be the sole determinant of the date of the initial system installation.

For residential installations in USA or Canada: If a product is defective in workmanship or materials and is removed and returned freight prepaid within three (3) years after the date of the initial system installation, Goldline will, at its option, either repair or replace the defective product and return it freight prepaid.

For commercial installations, installations outside the USA and Canada, and accessory products and replacement parts: If a product is defective in workmanship or materials and is removed and returned freight prepaid within one (1) year after the date of the initial system installation, Goldline will, at its option, either repair or replace the defective product and return it freight prepaid.

Contact any Goldline dealer or contact Goldline at 61 Whitecap Drive, North Kingstown, RI 02852 for warranty service. The costs incurred in removal and/or reinstallation of the product are NOT covered under this warranty. Some states do not allow limitations on how long an implied warranty lasts, so the above limitation may not apply to you.

WARRANTY EXCLUSIONS:

1. Material supplied or workmanship performed by others in process of installation.
2. Damage resulting from improper installation including installation on pools larger than the product rating.
3. Problems resulting from failure to operate the product(s) in accordance with the recommended instructions contained in product's owners manual(s).
4. Problems resulting from failure to maintain pool water chemistry in accordance with the recommendations in the owners manual(s).
5. Problems resulting from tampering, accident, abuse, negligence, unauthorized repairs or alternations, fire, flood, lightning, freezing, external water, degradation of natural stone used in or immediately adjacent to a pool or spa, war or acts of God.

DISCLAIMER. THE EXPRESS LIMITED WARRANTY ABOVE CONSTITUTES THE ENTIRE WARRANTY OF GOLDLINE WITH RESPECT TO ITS POOL AUTOMATION AND CHLORINATION PRODUCTS AND IS IN LIEU OF ALL OTHER WARRANTIES, EXPRESSED OR IMPLIED, INCLUDING WARRANTIES OF MERCHANTABILITY OR FITNESS FOR A PARTICULAR PURPOSE. THIS WARRANTY GIVES YOU SPECIFIC LEGAL RIGHTS, AND YOU MAY ALSO HAVE OTHER RIGHTS WHICH VARY FROM STATE TO STATE. IN NO EVENT SHALL GOLDLINE BE RESPONSIBLE FOR ANY CONSEQUENTIAL, SPECIAL OR INCIDENTAL DAMAGES OF ANY NATURE WHATSOEVER, INCLUDING, BUT NOT LIMITED TO, PERSONAL INJURY, PROPERTY DAMAGE, DAMAGE TO OR LOSS OF EQUIPMENT, LOST PROFITS OR REVENUE, COSTS OF RENTING REPLACEMENTS, AND OTHER ADDITIONAL EXPENSES, EVEN IF THE SELLER HAD BEEN ADVISED OF THE POSSIBILITY OF SUCH DAMAGES. SOME STATES DO NOT ALLOW THE EXCLUSION OF LIMITATION OF INCIDENTAL OR CONSEQUENTIAL DAMAGES, SO THE ABOVE LIMITATION OR EXCLUSION MAY NOT APPLY TO YOU.

NO WHOLESALE, AGENT, DEALER, CONTRACTOR OR OTHER PERSON IS AUTHORIZED TO GIVE ANY WARRANTY ON BEHALF OF GOLDLINE.

THIS WARRANTY IS VOID IF THE PRODUCT HAS BEEN ALTERED IN ANY WAY AFTER LEAVING THE FACTORY.

ELECTROLYTIC CHLORINE GENERATOR BASIC POOL MAINTENANCE REQUIREMENTS

	TEST	IDEAL RANGE	ADJUSTMENT REQUIRED
WEEKLY	Free Chlorine	1.0 - 3.0 ppm	Turn output dial up to increase, down to decrease -OR- increase or decrease pump filtration time.
	pH	7.2 - 7.6	Too high - add muriatic acid Too low - add soda ash.
MONTHLY	Alkalinity	80 - 120 ppm	Add baking soda to increase. Add acid as required to decrease.
	Salt	2700 - 3400 ppm	Add salt as required to increase.
QUARTERLY	Stabilizer	60 - 80 ppm	Add cyanuric acid to increase.
	Calcium	200 - 400 ppm	Add calcium to increase. Drain and add water to decrease.
	Electrolytic Cell	inspect & clean	Refer to section in manual.

Questions?

Refer to www.goldlinecontrols.com for latest manual revisions, additional information and helpful service. Or, you may visit your local Authorized Aqua Trol® Dealer or call 888-921-POOL (7665) for assistance.

